



DIGITAL PERISTALTIC DOSING PUMP

Model D-300/314D-4r

Code 1.9746.50



MANUAL

March 2024

Marked 

DINTER^{SA}

c/ Encarnació , 123 -125. Tel. +34 932 846 962. Fax +34 932 104 307
e-mail: dinter@dinko.es www.dinko.es 08024 - Barcelona

INDEX

	Page
1. GENERAL INTRODUCTION.	4
2. KNOW THE PERISTALTIC PUMP.	5
3. RECEPTION.	6
4. DESCRIPTION.	7
5. CHANGE OF TUBES.	9
6. HOW TO USE.	10
7. SPECIFICATIONS.	28
8. ORDERING INFORMATION.	29
9. MAINTENANCE.	30
10. ACCESSORIES.	30
11. CHANGE OF FUSES.	33
12. MAINTENANCE.	34
13. TROUBLESHOOTING.	35
14. PACKING LIST.	36
15. ANNEXES.	37
16. WARRANTY.	42
17. CE DECLARATION OF CONFORMITY.	43

Security



Please read this manual carefully before use!

- To avoid fire or electric shock, please do not use the pump outdoors, or in a humid environment.
- To reduce the risk of electric shock and the possibility of damage to the equipment, please use a standard 220 VAC grounded plug.
- When installing, first plug the 220VAC power cord into the socket on the back of the pump, then turn on the power.
- Please do not place heavy objects on the pump or allow liquid to enter the pump.
- Please do not cover the pump vents.
- Since some of the electrical components of the pump are in operation after the power is on, please turn off the power after stopping the pump, if it is not used for a long period of time, please unplug the power cord.
- The tube is the only consumable. Cracks due to tube wear may cause liquid to leak out of the tube, then it may cause harm to human or equipment. It depends on your understanding and control of the pumped liquid, with no legal causal relationship with the pump.

1. GENERAL INTRODUCTION.

Peristaltic pumps pump all kinds of liquid substances without coming into contact with the mechanical elements as in other pumps.

They are easy to use with minimal maintenance.

The pumped substance is propelled into an elastic tube by the vacuum generated by rotors that successively press and release the surface of the tube.

The liquid passes directly from its container to another without any contamination and without recoil when the pump is stopped since the tube is pressed by the roller.

Some aggressive substances prevent the use of conventional pumps and make peristaltic pumps very useful for the transfer or dispensing of such substances.

Flow rates are obtained from 0.01ml/minute.

Tubes or hoses of different sizes are available.

The following instructions are intended to ensure correct reception and use of the device, and the safety of the user.

For this purpose, we recommend reading this manual in detail before proceeding to unpack the device and subsequent use.

For the correct conservation of the device, it is necessary to avoid installing it in areas with corrosive atmospheres or exposed to liquid splashes.

Avoid using the device when there is the possibility of generating explosive and flammable gas mixtures.

2. GET TO KNOW THE PERISTALTIC PUMP.

The 300 series peristaltic pump is an intelligent pump that combines flow, timing and filling dosing functions. It can be operated by buttons, or controlled by an external signal or foot switch. It has a full speed emptying function and you can adjust the suction angle, etc. The high-definition LCD display shows pump speed, flow rate, operating parameters and other information on the same screen. It is a multifunctional intelligent product with the advantages of simple operation, stable and reliable performance, long-term continuous operation, and the ability to save input working parameters. It is suitable for bioengineering, chemical, pharmaceutical, hospital, food laboratories of production and research units, etc. It is an essential product for fluid testing and scientific research.



3. RECEPTION.

To guarantee correct reception, use of the device, and the safety of the user, we recommend reading this manual in detail before proceeding to unpack the device and subsequent use and especially the following points:

3.1- THE MANUAL.

This manual must be kept permanently within reach of the user of the equipment.

3.2- UNPACKING.

Unpack the device, checking that the contents match the packing list. Immediately notify any eventuality.

3.3- EXPLOSIVE MIXTURES.

Avoid using the device when there is the possibility of generating explosive and flammable gas mixtures. The ATEX Directive is not contemplated.

3.4- RESPONSIBILITY.





According to European regulation 89/655/EEC, the lack of adequate maintenance and the alteration of components exempts the manufacturer from any responsibility for any damage that may occur.

3.5- REPAIRS.

Devices to be sent to *DINKO technical services* must be **clean and disinfected**. Otherwise, they will be rejected and returned with shipping at the expense of the owner.

3.6- SIGNS AND SYMBOLS.

Pay attention at all times to the danger warning signs and symbols that appear in this manual or on labels attached to the body of the Pump such as those shown below.

SIGN/SYMBOL	INTERPRETATION-MEANING
	Avoid contact of fingers with moving parts
	Danger-Risk-Caution
<p>Before opening DISCONNECT the network cable Before removing cover PULL-OUT plug</p> 	Before accessing the interior of the Pump, disconnect the power cable from the mains.
	Possible overheating - Do not touch
110-230V AC 50/60Hz	AC supply voltage
110V AC 60Hz	AC supply voltage
12V DC or 24V DC	DC supply voltage
	<p>Disposal of waste electrical and electronic equipment by users within the European Union.</p> <p>It is not disposable as household waste. Deliver to the agency for recycling electronic equipment. Contact your local office, the store where you purchased the equipment or your household waste disposal service. Recycling helps conserve natural resources. Make sure it is recycled protecting human health and the environment.</p>

4. DESCRIPTION.

The D-300 peristaltic pumps in this manual have the 314D-4r head that allows the tube to be easily removed for extraction when it must be replaced due to tube wear or for the use of another tube with a different interior diameter.

Simply pull up on the top of the head.

When installing a tube, you must face it in its position, push down and adjust the side retainers of the tube by turning the wheel for this purpose. See section 4.1.

The head accepts various tube sizes that, combined with speed regulation, give a wide variety of flows, as can be seen in the indicative flow table.

With the **Full Speed (FS) key**, the maximum engine speed is obtained during loading, purging and cleaning operations.

The **CW/CCW (CW) key** allows you to choose the direction of rotation of the motor for flow reversal.

On the back there is the connection for the network cable with integrated fuse holder, connection for foot pedal and input for 0-10 V and 4-20 mA signal.



Consult the indicative dosage table and install the appropriate tube.

4.1 CF-4r PUMP HEAD.
Head opening and adjustment.

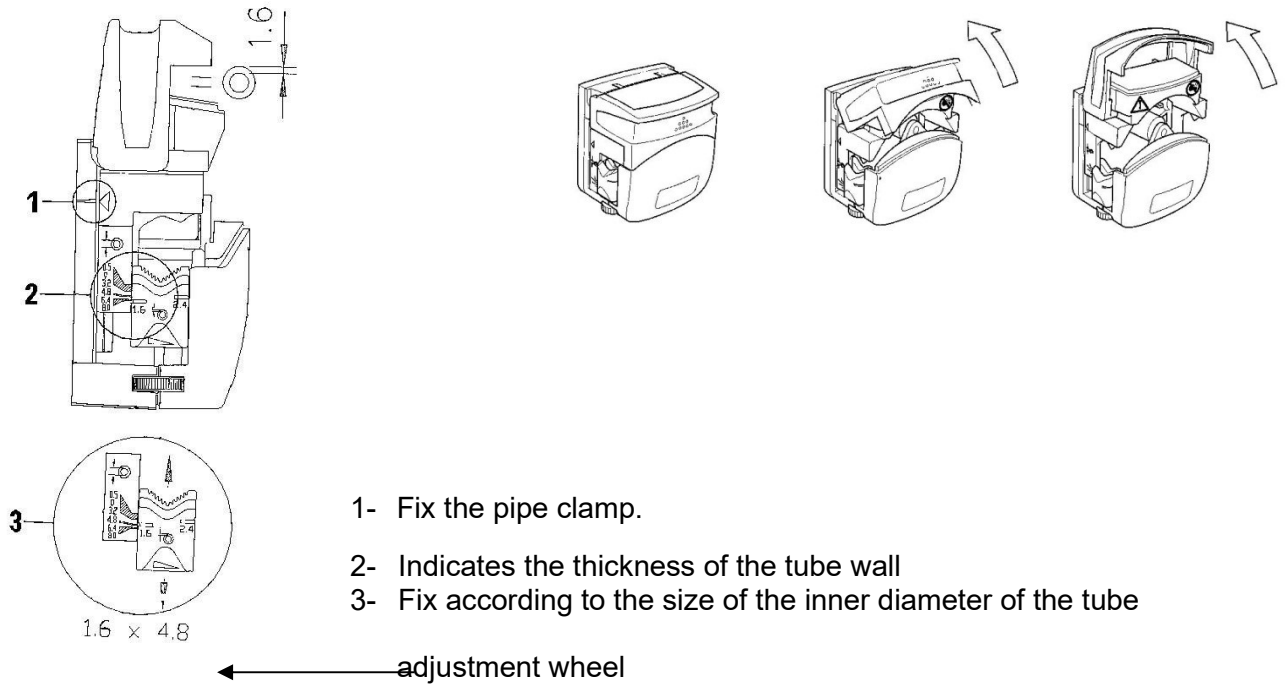

Tube loading.

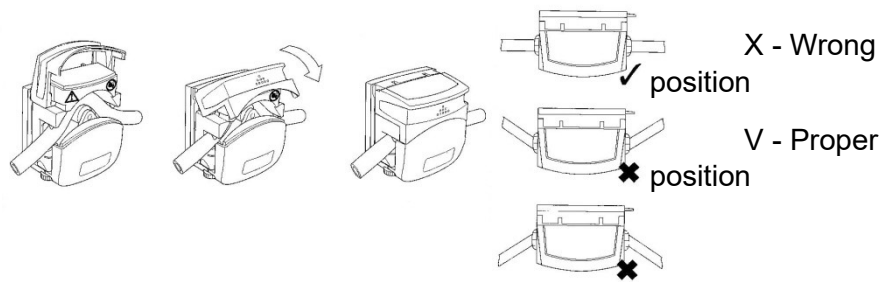

5. CHANGE OF TUBES.

Press the OFF switch. Extract the tube according to the instructions described in the "Description" and "Head" sections.

When installing the tube, it should be somewhat taut. Check that the pump is OFF.

The tube lengthens in the first 30 minutes of operation. You must tighten it again and avoid unexpected breakage. To detect the extension, mark the tube with a marker.

The silicone tubes supplied with each pump have a 1.6mm wall.

Durability depends above all on the chemical nature of the pumped liquid, pressure, temperature and engine revolutions.

The choice of the inner diameter of the tube avoids high engine revolutions with small diameter tubes and decreased tube life.

AVAILABLE MATERIALS:

PHARMA	Autoclavable multiple times. Sterilizable by ETO and Gamma. Food-medical grade, USP class VI, 21CFR 177.2600 and FDA. Not hemolytic. Excellent resistance to chemicals. ISO 10993. Low permeability and good abrasion resistance. Long duration. Temperature of use, -51°C to 130°C. Beige.
SILICONE	Autoclavable. The most versatile tube. Platinum Cure quality silicone. Average duration. Medical/Food Grade. Excellent biocompatibility. Maximum temperature. 140°C. Translucent.
TYGON A-60-C ®	Autoclavable multiple times. Food grade. Long lasting. Resistant to acids, alkalis, oxidizing agents. Use temperature: -59°C to 135°C. Beige.
TYGON A-60-G ®	Autoclavable. Compatible with Ozone, UV light and disinfectants. Great resistance to fatigue and abrasion. Resistant to acids, alkalis and alcohols. Temperature of use -59°C to 135°C. Black color.
VITON ®	Autoclavable. Suitable for acids and non-ketonic solvents. Maximum temperature 300°C. Black color.

6. HOW TO USE.

6.1 Front panel description:

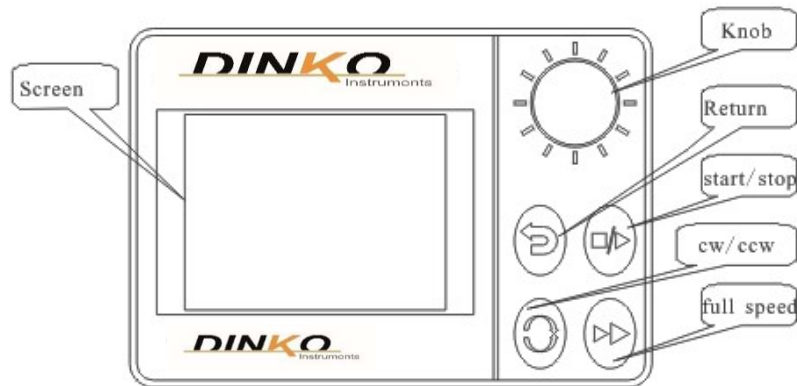

- **Screen (Screen):** where the different menus are displayed.
- **Knob (K):** It is the button for selecting and configuring all parameters. With the external control activated the button (K) is only used for function selection. This knob can be turned to raise or lower the different values to be configured or pressed to validate.
- **Return (R):** Used to return to the menu options of the previous level.
- **Start /Stop (S):** Button to start or stop the programmed technique.
- **CW/CCW (CW):** Button to choose the direction of rotation, CW clockwise and CCW counterclockwise.
- **Full Speed (FS):** When pressed, the pump will rotate at its maximum speed, when pressed again it will return to the original speed. It is usually used for cleaning, emptying or priming the pump.

6.2 Pump control modes:

The pump can work with three types of control:

- **With the selection button (K):** With this type, with the button (K) we can modify and select all the options.
- **With foot switch or pedal:** The pump recognizes when it is connected and is used as a substitute for the Start / Stop(S) button.
- **External signal control:** Through the connector supplied with the pump, the pump can be externally controlled using 0-5 V, 0-10 V, 4-20 mA or RS485.

6.3 Starting the pump.

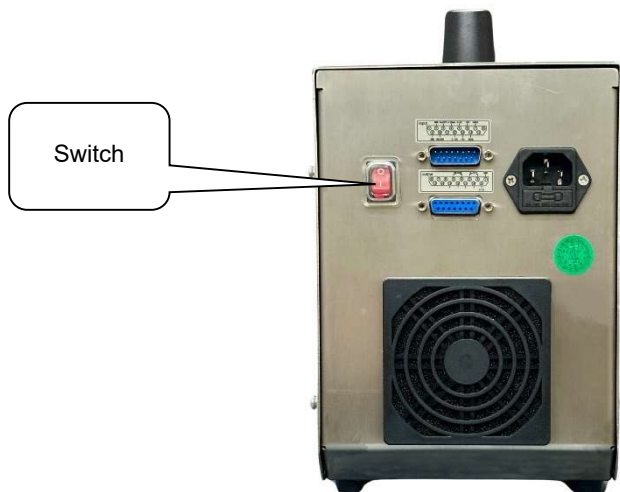

Turn on the pump with the red switch located on the back.

The peristaltic pump has a power-off memory function. If when we turn off the pump, we do so by holding down the Start / Stop button (S), it memorizes the last established Mode, which will be the mode that will appear when we turn on the peristaltic pump again.

The screen will turn on and the mode and data that was used last time will appear, as long as it has been memorized.

We are going to describe the different modes of work:

- **Working modes:**
 - **Timing:** In this mode it works by programming the operating time and the stop time.
 - **Speed:** The pump is controlled by modifying the speed.
 - **Filling:** This working mode is used to dose a certain volume, once or several times, as many times as we configure.

The pump is factory configured in Speed mode.



Main menu:

By pressing the selection button (K) for three seconds, we will enter the main menu.



Description of the different sections:

- 1- **Mode:** Where we select the work mode.
- 2- **Parameter:** We configure the characteristics of the pump.
- 3- **Timing:** To configure this working mode.
- 4- **Filling:** To configure this working mode.
- 5- **Check:** To recalibrate the pump, adjust the dispensed volume.
- 6- **Default:** To return the pump to factory settings.
- 7- **Instruction:** A small operating manual.
- 8- **Engine:** To modify the engine used (**DO NOT TOUCH**).

Before selecting the working mode (Mode), you must go to the Parameter section, turning the selection button (K) we go to Parameter that is highlighted in another color and press the selection button (K).

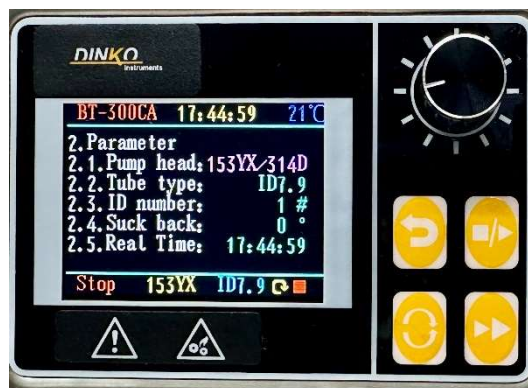

We are going to detail the eight parameters that can be configured.

To enter each section or validate the selection made in a section, we press the selection button (K), to move, we turn it.

2. Parameter.

This section consists of two screens.

2.1. Pump Head: Here we choose which head the pump is working with, by default it is already configured with the head it mounts. This equipment mounts the 314D pump head.



2.2. Tube type: Here we can choose which tube we are going to work with, depending on the chosen head, the different tube sizes that we can use with the chosen head will appear, we select the one we are going to work with. Once selected, it informs us of the flow rate with said tube, in case we want to assign another tube with more or less flow rate.



23. ID number: The number with which we identify the pump is useful if we have more than one pump and we can identify up to 10 different devices.



2.4. Suck Back: In this section we activate the anti-drip function, we choose the degrees that the motor will rotate in the opposite direction at the end of the dosage.



2.5. Real Time: To adjust the device's time.



To go to the second Parameter screen, we turn the knob (K) to the right.

2.6. Foot switch: Allows you to select the pedal operating mode.



Inching U: The pedal will work by giving one pulse to start and another to stop, exactly the same as the **start/stop** button. For all working modes.

Abiding Z: When you press the pedal the pump works and when you release it, it stops. Only work like this in **speed mode**.

2.7. External control: Here we can select whether or not we are going to use external control.



2.8. Control type: We can select between different types of external control 0 -5 V, 0-1 V, 4-20 mA or RS485.



Once all the parameters have been configured correctly, we are going to select which work mode we are going to use.

We enter the main menu by pressing the selection control (K) for three seconds.



We select **1. Mode** by pressing the selection knob (K), the three work modes will appear on the screen.



By turning the selection knob (K), we choose which working mode we are going to use:

- **Timing:** When we press the selection control (K) on Timing, it will take us to the **3. Timing menu** from the main menu and will show us the different parameters to configure.

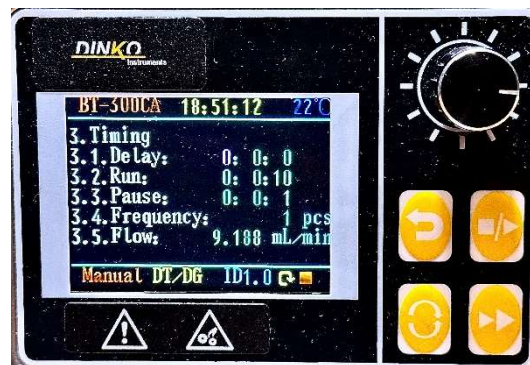

3. Timing

3.1. Delay: Here we can enter the waiting time before starting to dose. We choose the time in hours: minutes: seconds (00:00:00), we move between the different sections, we press the control (K) and by turning it we raise or lower the different values.



3.2. Run: Here we enter the time we want the pump to run to make a dosage. We choose the time in hours: minutes: seconds (00:00:00).



3.3. Pause: We select the waiting time between two doses. We choose the time in hours: minutes: seconds (00:00:00).



3.4. Frequency: We can indicate how many times we want the dosage to be repeated.



3.5. Flow: We select the flow in ml/min that we want the pump to work with, always with the limitation that we have due to the tube we are using.

All sections must have some digit, except the initial waiting time, which can be zero.

For example, to operate for ten seconds only once, the screen will look like this.



We press Return (R) and we will enter the main menu, we press (R) again and the work screen appears.

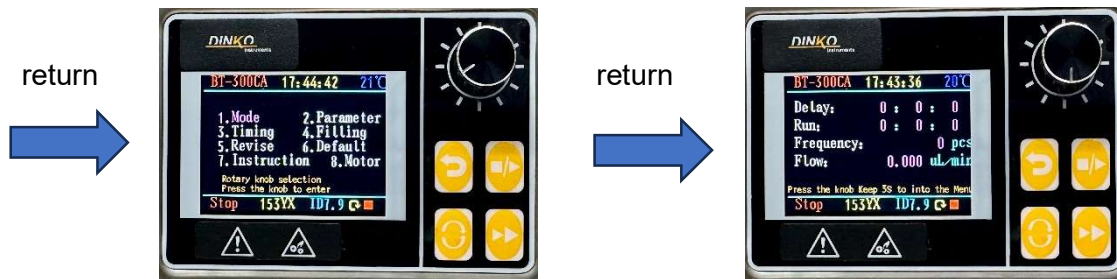

When you press Start /Stop(S) the motor will rotate and will indicate the operating time and flow rate on the screen.

- **Speed:** With this mode we will control the pump flow rate by the motor speed. It is used to transfer or fill a bottle manually.

When we press the selection knob (K) on Speed, Parameter appears, as we have already programmed it, we do not touch anything.

We press Return (R) and we will enter the main menu, we press (R) again and the work screen appears.

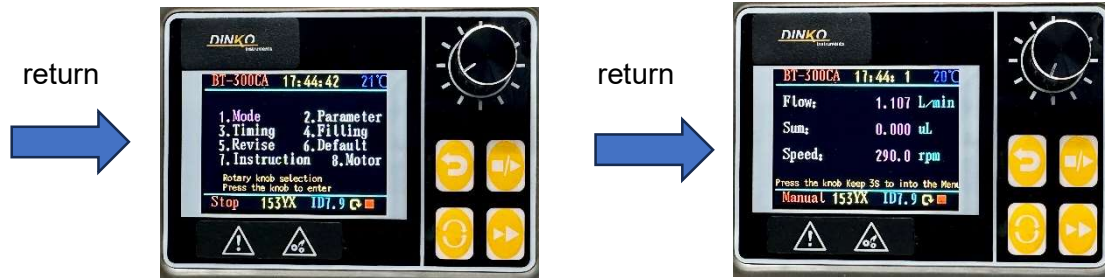

When you press Start /Stop(S), the motor will rotate, and the screen will indicate the flow and speed at which we are working.

The speed can be varied without stopping the pump by turning the selection knob (K).

To stop the pump press (S).

- **Filling:** We will use this mode for dosages, both single and multiple. When we press the selection knob (K) on Filling, it will take us to menu **4. Filling** from the main menu and will show us the different parameters to configure.



4. Filling

4.1. Flux: In this section we will enter the volume that we want to dose. Depending on the head we have in the equipment, the minimum and maximum dosage varies.

Using the selection knob we can set the volume to be dosed, we confirm by pressing the selection knob (K).



4.2. Run: In this section we enter the time in which we want the desired volume to be dispensed. If the selection is out of range, the speed and flow will be blank, and a message appears indicating that the speed is out of range and that the dosing time should be increased. Choose the new time and confirm by pressing the selection knob. (K).



4.3 Pause: Here you enter the waiting time between doses, confirm by pressing the selection knob (K).

This section must have some value, even if you want a single dosage, for example 1 second.



4.4 Frequency: In this section We can choose the number of doses to be carried out, you can choose between 1 and 90,000, always program at least one dose, confirm by pressing the selection knob (K).

4.5 Type: In this section we determine the type of control. Choose Timing and confirm by pressing the selection knob (K).



In this way we have programmed the dosage. To work, press (R) and enter the main menu in **Filling**, press (R) again and the screen to dose appears.

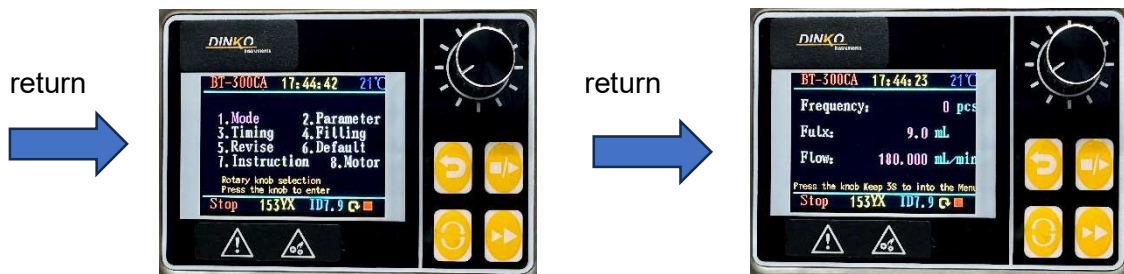

To dose, press (S), the pump will start and do what we have programmed, accumulating the time and flow rate that has elapsed.

5. Review.

The pump is factory calibrated for silicone tubes and clean water at a temperature of 20°C on a horizontal surface and a tube length of 1 meter.

This section of the menu helps us recalibrate the pump for certain working conditions.

We will enter this section once we have configured the **Parameter menu**.

There are three types of calibration depending on the working mode:

- **Timing** → **Timed Correction.**
- **Speed** → **Traffic Correction.**
- **Filling** → **Filling Correction.**

5. Timed Correction:

To enter this section, we select **Mode** from the main menu, select **Timing** and confirm by pressing (K).

Fill out and confirm the Timing data. Press (R), we enter the main menu and select **Review** and press (K).



Timed appears on the screen **Correction.**



It allows us to modify the time and speed, the volume will vary automatically. Confirm by pressing (K), the following screen appears with the volume to measure. We press (S) and measure the volume supplied.



We enter the actual measured value by turning the knob (K) and confirm by pressing.



You will return to the previous screen with the speed and flow modified.



5. Traffic Correction:

To enter this section, we select **Mode** from the main menu, select **Speed** and confirm by pressing (K).

Press (R), we enter the main menu and select **Review** and press (K).



Appears on screen **Traffic Correction**.



It allows us to modify the time and speed, the volume will vary automatically.

Confirm by pressing (K), the following screen appears with the volume to measure.

We press (S) and measure the volume supplied.

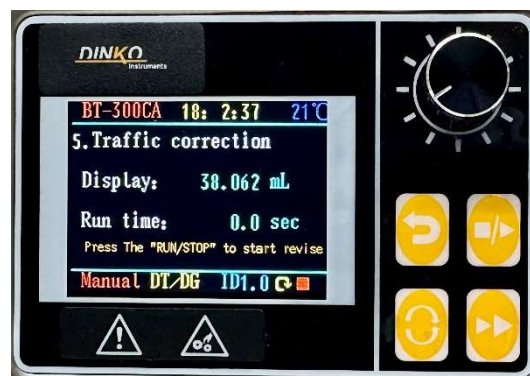

We enter the actual measured value by turning the knob (K) and confirm by pressing.



You will return to the previous screen with the speed and flow modified.



5. Filling Correction:

To enter this section, we select **Mode** from the main menu, select **Filling** and confirm by pressing (K).

Filling data. Press (R), we enter the main menu and select **Review** and press (K).



Filling appears on the screen **Correction**, with the values that will perform the calibration, which are those of three dosages, to average.



If correct, confirm the values by pressing (K)

The value that will be dosed appears on the screen, which will be three times that of a dosage.



By pressing (S) you will carry out the 3 dosages, we measure the real value obtained and enter it into the equipment with the control (K), confirm by pressing



the control (K).

Appears with the modified speed.



We press (R) and it will return to the main menu.

7. SPECIFICATIONS.

1) Specifications.

Smart Unit/ Code	D-300/314D-4r/1.9746.50
Speed range	0.1 - 300rpm
Maximum speed	300rpm
Speed resolution	0.1rpm
Maximum suction vacuum	0.17MPa
Maximum outlet pressure	0.17MPa
Control mode	Membrane keyboard
Principal function	Manual control, automation, timing, filling, external control
External control	0-5V, 0-10V, 4-20mA, RS485
Display	LCD
Power and current	AC 100 - 240 V +/-10%, 50 Hz/60 Hz 3.0 A
Consumption power	<36W
Type of motor	DC brushless motor with reducer
Engine life	6000 – 20,000 hours
Working conditions	Temperature 0-60 °C, relative humidity <85%
Equipment dimensions	Length 240 x Width 160 x Height 322.5 mm
Unit Weight	3.5kg _
IP Rating	IP 31
Pump head	314D-4r/ Code 1.0078.02

Table of indicative flow rates per channel-314D-4r Pump head

Tube ID mm.	0.5	0.8	1.6	2.4	3.2	4.0	4.8	6.4	8.0
ml / 0.1rpm.	0.002	0.006	0.027	0.05	0.09	0.14	0.19	0.30	0.40
ml / 300rpm	6.0	18.0	80.0	140.0	270.0	500	600	900	1240

Flow description:

1. The flow rate is measured at an ambient temperature of 23°C and without pressure at the inlet and outlet, and when clean water is transported at the same level at a distance of one meter.
2. The total flow of multiple channels is equal to the flow of a single channel of the pump times the number of channels of the pump.

8. ORDERING INFORMATION.

Code ▼	Articles
1.9746.50	Dispensing Peristaltic Pump. Mod. D-300/314D-4r, 100...230V 50/60Hz
1.0078.02	Pump head 314D-4r
1.8760.05	Silicone tube 0.5mm ID,1.6mm TW, 1 meter
1.8760.08	Silicone tube 0.8mm ID,1.6mm TW - (13#), 1 meter
1.8760.16	Silicone tube 1.6mm ID,1.6mm TW - (14#), 1 meter
1.8760.24	Silicone tube 2.4mm ID,1.6mm TW - (19#), 1 meter
1.8760.32	Silicone tube 3.2mm ID,1.6mm TW - (16#), 1 meter
1.8760.48	Silicone tube 4.8mm ID,1.6mm TW - (25#), 1 meter
1.8760.64	Silicone tube 6.4mm ID,1.6mm TW - (17#), 1 meter
1.8760.80	Silicone tube 8.0mm ID,1.6mm TW - (18#), 1 meter

9. MAINTENANCE.

Before any examination or repair of the device, it is necessary to disconnect the mains socket.

All initiatives must be carried out by qualified personnel to avoid greater harm.

Entrust your device to a technical service authorized by *DINKO Instruments*.



The engine and its block do not require lubrication, so they are maintenance-free. The rotor bearings are self-lubricating, but it is advisable to lubricate them lightly with silicone grease ref. 8.0030.03 or similar from time to time, especially if they have been washed.
See Figure

The head tube must be replaced periodically in a systematic manner to avoid the inconvenience of breaking it while the pump is in full operation.

Important: The head tubes should be lightly greased with silicone grease to extend their life and facilitate starting at low rpm.

Silicone Grease, 50g for lubricating peristaltic tubes. Code 8.0030.03

10. ACCESSORIES.

10.1 Scale for calibration of flow rates and dosages.



Reproducibility 0.01 g. Capacity 500g. Code 1.9812.04

To measure the dosed quantity in the Calibration process of peristaltic pumps, it is very effective to use a precision scale with digital reading.

If the liquid to be pumped has a density of “1” there will be no difference between grams and milliliters. Otherwise, calculate the density by weighing a quantity of the liquid with the help of a test tube, for example, 25 ml, previously weighing the test tube on the balance.

Divide the weight indicated on the digital reader of the scale in grams by the milliliters contained in the test tube to obtain the density according to the relationship:

$$D= M / V.$$

There is always the option to Calibrate the pump directly based on weight instead of volume.

Characteristics:

- ◆ Mono digital reading plate, with highly visible backlit LCD screen.
- ◆ Simple use and great robustness with ABS casing and airtight, moisture-proof membrane keyboard.
- ◆ Stainless steel plate, 157x128mm.
- ◆ External auto calibration.
- ◆ Measurement units: grams, pounds and ounces.
- ◆ Continuous tare up to 500 g.
- ◆ Power supply 230V 50/60Hz.
- ◆ Non-slip rubber feet.
- ◆ Working temperature: from +5°C to +40°C. Maximum humidity of use, 85% RH.

10.2 Graduated cylinder, 25 ml. Code 1.9808.20

10.3 Silicone Grease, 50g. Lubricated peristaltic tubes and rollers. Code 8.0030.03

10.4 Foot support. Code 1.8003.08

Useful as a support for the dosing tube/tip. Foot: 150 x 70cm. Bar, height 70cm. Sliding support for dispensing tip.

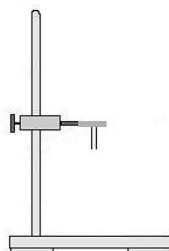

CONNECTORS FOR PERISTALTIC TUBES

10.5 Reducing Connectors - Splice/Equal Ends, Polypropylene



For tubes with 1.6mm ID. Code 1.0080.15
For tubes with 3.2mm ID. Code 1.0080.18
For tubes with 4.8mm ID. Code 1.0080.05
For tubes with 6.4/8mm ID. Code 1.0080.14
For tubes with 9/12mm ID. Code 1.0080.20

10.6 Y-shaped connectors, polypropylene

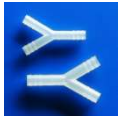

Y shape connector, 6mm. either. Code 1.0120.26
Y-shaped connector, 8mm. either. Code 1.0120.48
Y shape connector, 10mm. either. Code 1.0120.32 Y-shaped
connector, 12mm. either. Code 1.0120.33

10.7 316 stainless steel tube connectors - Splicing and dosing

Straight splice 40mm length



Tube for peristaltic tubes 0.5 and 0.8mm Ø, 25 pcs. Code 8.0056.14
Tube for peristaltic tubes 1.6mm Ø, 25 pcs Code 8.0056.06
Tube for peristaltic tubes 3.2mm Ø, 25 pcs Code 8.0056.08
Tube for peristaltic tubes 4.8mm Ø, 25 pcs Code 8.0056.10
Tube for peristaltic tubes 6.4mm Ø, 25 pcs Code 8.0056.12

Dosing 130mm length with a bevel

Dosing tube for peristaltic tubes 0.5 and 0.8mm Ø, 10 pcs. Code 8.0056.15
Dosing tube for peristaltic tubes 1.6mm Ø, 10 pcs Code 8.0056.07
Dosing tube for peristaltic tubes 3.2mm Ø, 10 pcs Code 8.0056.09
Dosing tube for peristaltic tubes 4.8mm Ø, 10 pcs Code 8.0056.11
Dosing tube for peristaltic tubes 6.4mm Ø, 10 pcs Code 8.0056.13

Length 38mm



Micro-tube 0.8mm OD, 10 pcs. Code 1.0077.23
Micro-tube 0.9mm OD, 10 pcs. Code 1.0077.26



Clamping flange P. Code 1.0120.01
Clamping flange G. Code 1.0120.12

10.8 Anti floats 304 stainless steel for suction tubes.



For peristaltic tubes with 1.6 and 3.2mm ID Code 1.0303.10

For peristaltic tubes with 4.8mm ID. Code 1.0303.11

For peristaltic tubes with 6.4mm ID. Code 1.0303.12

For peristaltic tubes with 8.0mm ID. Code 1.0303.13

For peristaltic tubes with 9.6mm ID. Code 1.0303.14

For peristaltic tubes with 12.7mm ID. Code 1.0303.15

10.9 Stainless steel dosing tubes with non-return valve.



For 3.2 and 4.8mm ID tubes. Stainless steel tip. 4mm OD 1mm TW. Code 1.0302.10

For 4.8 and 6.4mm ID tubes. Stainless steel tip. 6mm OD 1mm TW. Code 1.0302.11

For 6.4 and 8mm ID tubes. Stainless steel tip. 8mm OD 1mm TW Code 1.0302.12

For 8 and 9.6mm ID tubes. Stainless steel tip. 10mm OD 1mm TW Code 1.0302.13

11. CHANGING FUSES.

The fuse holder box is part of the power supply base located at the back of the pump. See Figure.

Fuse holder box



Power base

Pry with a screwdriver between the central part of the fuse holder box and the top part of the power supply base to remove the fuse holder box. The box remains attached without being completely removed. There are two fuses.

Press the box inwards to restore its original position.

It must be remembered that the spare fuse has already been used.

12. MAINTENANCE.

- 1) Before each start of the peristaltic pump, carefully check whether the tube is damaged. Before the machine stops working, please pump water to clean the tube. To extend the life of the tube, especially after running at high speed (100rpm or more) for 8 hours, the tube should be pulled out (suction end) 80 to 100mm to prevent the tube from shifting, being crushed in a certain fixed point due to the compression of the tube by the roller and damage to the tube due to excessive wear or bending (especially for the normal life of the tube).
- 2) Silicone tube is not resistant to strong acids, strong alkalis, organic solvents. It is best to use a small length of silicone tubing to dip into the solution to be pumped before use, to avoid corrosion and rupture of the tubing during use, causing the liquid to leak and corrode the pump head. the pump and flow into the pump body to damage the machine.
- 3) Often check the extruded part of the silicone tube to prevent the tube from aging and damage, to prevent the liquid from flowing into the pump body and damaging the motor and circuit. When it is found that the silicone tube is aging, it should be replaced in time. In order to extend the life of the silicone tube, the extruded part of the silicone tube is often replaced. The silicone tube should be removed when not in use for a long time.
- 4) Since the roller is rolling and rubbing, it is necessary to keep the inside of the rolling groove clean.
- 5) The tube used in the peristaltic pump is a special high-elastic silicone tube. During the use of the pump, other tubes should not be used instead (if you need to pump strong acid, strong alkali, long-lasting organic or mild solvent, please contact us to purchase).

13. TROUBLESHOOTING.

Item	Problem	Inspection	Treatment	Observation
1	Screen without display	Plug on or not	Check the line	Safety built into the socket
2	Normal screen display, but pump does not work	Correct or incorrect control	Check settings and reboot	
		Pump head High pressure. Tube too tight or not	Adjust	
		Tube size suitable for pump head or not	Choose the right tube	
		Loose cable or not	Check and resume	
		Damaged drive, motor or others	Check and replace	
3	The pump works, but cannot pump liquid	Check that the tube is tightly compressed at the top of the pump head	Fit tight	
		Check the tube damaged or not	Replace the tube	Observe the wall of the tube
4	The tube slides together with the rollers	Check whether the pipe clamp is loose or not	Adjust the tube clip	
5	Stop during operation	Set function	Restart	
6	Tube with premature cracks	Flexible roller or not	Fixed roller	Tube quality

14. PACKING LIST

Article	Name	Unit	Amount	Observation
1	Smart drive		1	
2	CF-4r pump head		1	
3	Power cord		1	
4	Foot switch		1	
5	15-pin male connectors		1	
6	15-pin female connectors		1	
7	Silicone tube	meter	1	
8	Manual		1	
9	Warranty card		1	

15. TO NEXOS.

Annex 1 BT-CA series control mode

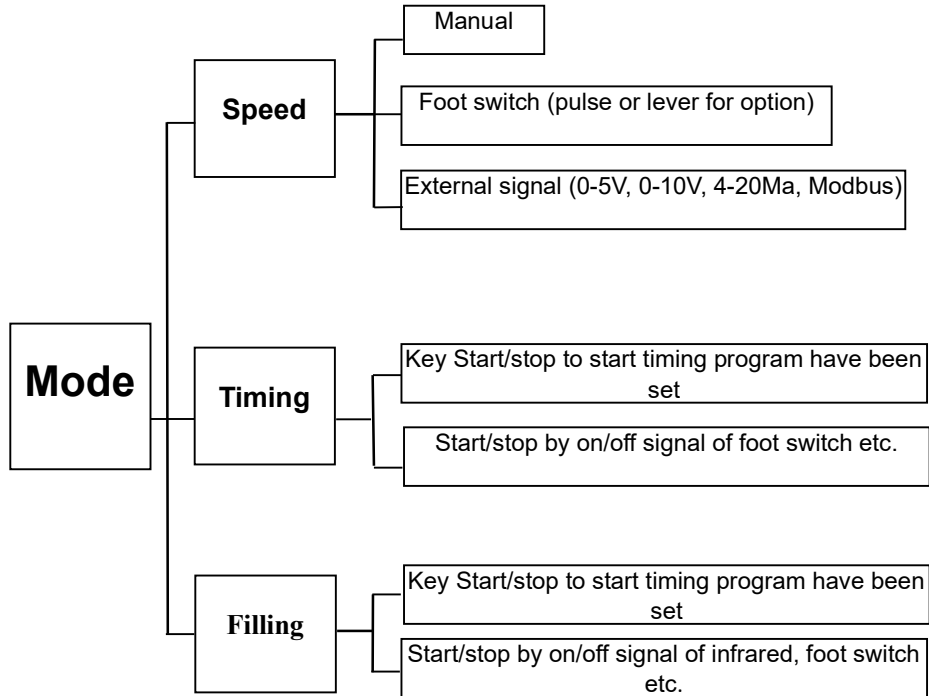

Annex 2 Definition of external control terminal

Definition of input terminal

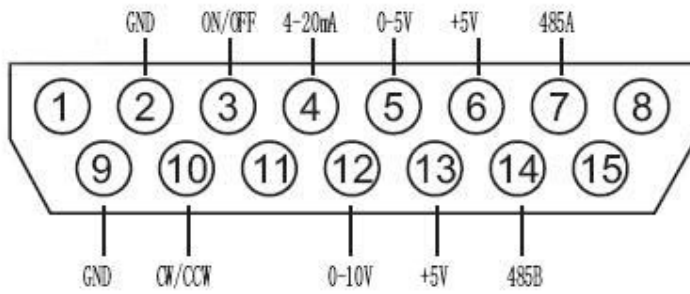

- 1) ON/OFF is start and stop control, CW/CCW is positive and negative control. For external control switch, short circuit or hung up to control.
- 2) GND is ground, which is the ground of the external control input signal.
- 3) When the pump is operated using the foot switch or value switch,
Please short circuit the terminal ⑨ and ⑩ , and change the value to ② and ③ .
- 4) ⑦ and ⑭ are 485 communication interface terminals.

Definition of exit status

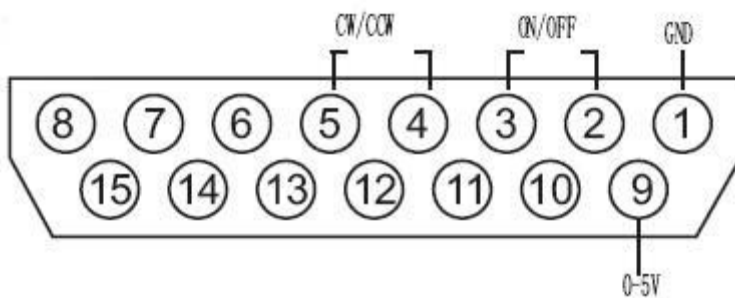

- 1) 0-5V for external output voltage signal
- 2) ② and ③ for start/stop relay output contact
- 3) ④ and ⑤ for steering relay output contact

Annex 3 DB15 External wiring

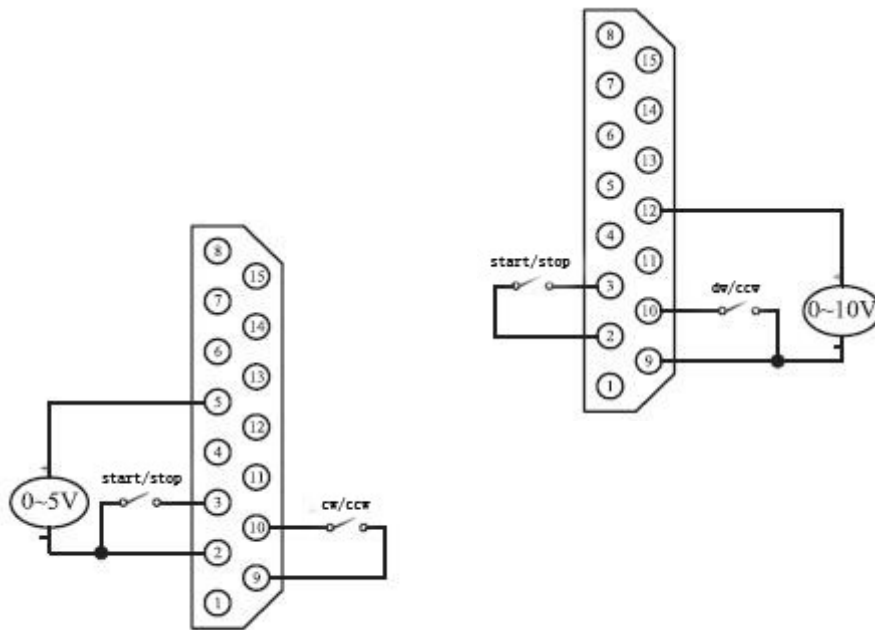

External control mode 1: 0 ~ 5V External control mode 2: 0 ~ 10 V

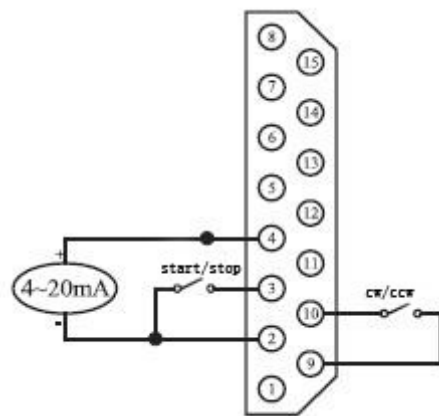

External control mode 3: 4~20mA

Annex 3 DB15 External wiring

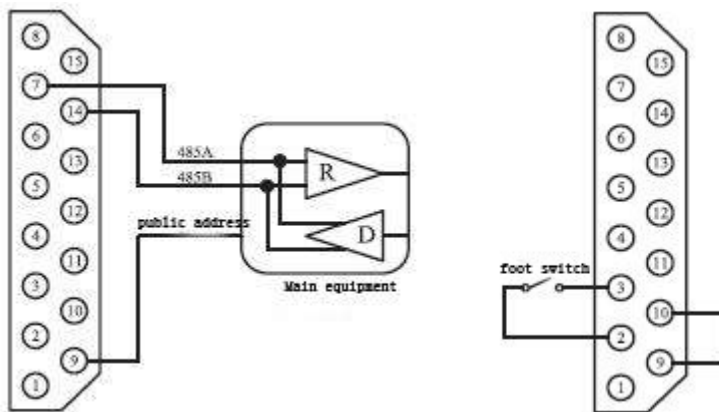

External control mode 4: Modbus - rtu Foot switch

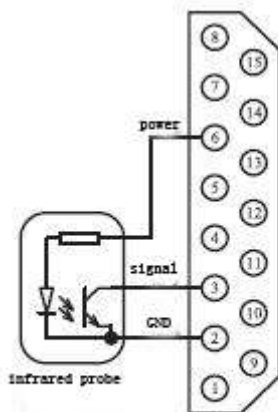

Infrared switch

1. Use external control mode, 1-4 to enable external control and select the corresponding external control mode.
2. When using a switch such as a foot switch or infrared, it is necessary to ensure that the external control is turned off.
3. Start and stop switch, positive and negative switch, foot switch and infrared sensor, must be dry contact switch or open collector pull-down output type interface;
4. The foot switch provides pulse or electric display type in flow mode, and single pulse signal is provided in timing and filling mode.

Annex 4 Modbus Parameter

No.	Article	Content
1	Communication data format	rtu standard communication protocol, baud rate 9600, 8 data bits, 1 stop bit, even parity check.
2	Command code done	Modbus- rtu uses the command code 02,04,06,15, the starting addresses are all 999.
3	02 discrete signal input	Command 02 bit address 999 is start/stop signal, 1 for start, 0 for stop. 1000 is CW/CCW signal, 1 for CW, 0 for CCW.
4	04 check-in	The command word address 04 999 is the rotation speed signal, 1000 is the temperature signal, the data are all integers.
5	06 check out	The command word address 06 999 is rotation speed control, the data is all integers.
6	15 discrete signal outputs	15-bit command address 999 is rotation speed control, 1000 is CW/CCW control.
7	Modbus output control	Modbus output control rotation, start/stop, CW/CCW, can only be performed under external Modbus control .
8	Modbus input collection	Pick up rotation speed, start/stop, cw / ccw signal in any mode. In flow mode, it can collect flow coefficient and accumulated flow data.
9	Machine address	The machine address is set in basic parameters, effective range from 1 to 30. After changing the settings, power-on initialization is needed.

16. WARRANTY.

16.1 DURATION:

The warranty is established for a period of 1 year from the date of commissioning of the device as long as the warranty card is returned to us within 8 days following said commissioning.

Without this condition the guarantee will not be valid.

16.2 SCOPE OF WARRANTY:

The guarantee is given against manufacturing and material defects for an average of 40 hours of work per week.

The guarantee is reduced proportionally to the increase in working hours.

Repairs will be carried out in our factory.

Otherwise, the warranty will only include the replacement of defective elements.

DINKO will not be responsible for transportation costs, nor will it assume responsibility for the consequences caused by the immobilization of the device.

The free replaced parts remain our property, reserving the right to request their return, free of shipping to our home.

Repairs or replacement of parts during the warranty period do not extend the initial warranty.

Our liability is limited to the attached warranty and not to possible accidents to people or other things.

Any alteration of the device by the user voids the warranty.

17. "CE" DECLARATION OF CONFORMITY.

DINTER SA *DINKO Instruments* c/ Encarnación, 123-125 / 08024- Barcelona

Declares that the articles mentioned in the attached list, to which this declaration refers, comply with the essential safety requirements of the applicable European Directive:

- Low Voltage Directive D2006/95/EEC of December 12, 2006

- Essential requirements of Annex I of the Machinery Directive 2006/42/EEC of May 17, 2006

- Electromagnetic compatibility EC relative to the Electromagnetic Compatibility Directive 2004/108/EEC of December 15, 2004

- Safety for electrical measurement, control and laboratory devices. EMC regulations. EN 61326

- Safety rules for electrical measurement, control and laboratory devices. Part I. General requirements EN 61010-1

However, the user must observe the assembly and connection instructions indicated in the technical instruction catalogues.

Name	Joan A. Bravo	Josep X. Sensada
Post:	Technical Director	Responsible for Quality

Signature		
-----------	---	--

Model: D-300/CF-4r Peristaltic Pumps. Codes 1. 9746.50

OTHER DINKO APPARATUS / OTHER DINKO APPARATUS

- Blenders-Homogenizers
 - Colorimeters
- Conductivity Meters
 - Dosing Pumps
- Extractor for meat analysis
 - Heating Plates
 - Infrared Stoves
- Kits for water analysis
- Magnetic Stirrers
 - Metallic block heaters
 - Microscopes
 - Nephelometers
 - Orbital Shakers
 - Oximeters
 - Peristaltic Pumps
 - pH-meters
 - Photometers
 - Respirometers
 - Rod Stirrers
 - Rotary Stirrers
 - Sand Baths
 - Spectrophotometers
- Temperature Controllers
 - Timers / *Timers*
- Trichinoscope – TriquiVisor HD-XY
 - Turbidity Meters
 - Turn dishes
 - Vacuum Pumps



DINTER, S.A. c/ Encarnació, 123-125. Tel. +34 93 284 69 62 Fax +34 93 210 43 07.

08024-Barcelona

dinter@dinko.es

www.dinko.es